

PureLink

SMART CAMERA, SOUNDBAR, MICROPHONE AND VIDEO SWITCHER

All-In-One Conferencing Solution

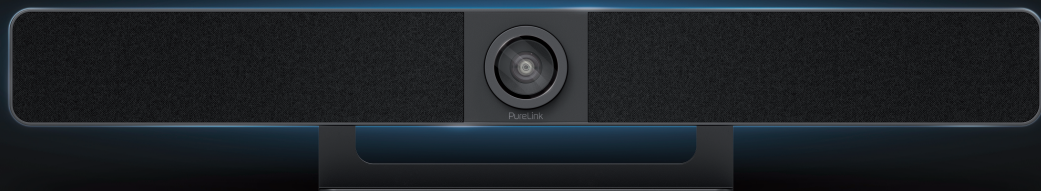

USER MANUAL

 **Vuelogic**

VL-VB300





TABLE OF CONTENTS

Introduction	3
Features	3
Package Contents	4
Specifications	4-5
Panel Description	6-7
Installation	8
Application	9-11
Automatic Signal Switching	12
Pairing with Bluetooth Remote Controller	12-13
Screen Mirroring	14-15
Using Apple Devices	14
Using Android Phones	14
Using Windows PCs	15
Web UI	15-23
Camera	17-18
Settings	19
General Settings	19
Video Settings	20
Wi-Fi Settings	21
BYOD Settings	22
System Settings	23
Support	23
Trouble shooting	24
CE Conformity	25
Disposal of device	25
Battery Recycling Information	25
Disclaimer of liability	26
Trademark	26

INTRODUCTION

This product is an all-in-one meeting videobar with ultra-wide angle 4K camera, microphone and speaker, as well as wired and wireless screen casting capability. It is ideal for teleconference and collaboration applications in huddle rooms and small to medium meeting rooms.

FEATURES

- Smart video conference collaboration device. All-in-one solution for all meeting scenarios
- Wired screen presentation via USB-C and HDMI
- Wireless BYOD via Airplay, Miracast and Dongle
- Wide angle 4K video camera with 120° FOV
- 4 x MEMS digital microphone arrays with a range of 5 ~ 8 meters and an angle of 180°
- 2 x 5W Stereo full range speakers with passive radiator bass enhancement
- Includes AEC (Acoustic Echo Cancellation), AGC (Automatic Gain Control), ANS (Automatic Noise Suppression) and full duplex mode communication to make all participants feel like they are in the same room
- Auto Framing / Speaker Tracking / Presenter Tracking based on AI technology makes meetings more intimate and friendly
- Plug and play with excellent compatibility for OS and UC applications, e.g. Zoom, Teams, Webex, Tencent Meeting, etc.
- Provides flexible control options via Web GUI and Remote Controller
- Built-in Wi-Fi



PACKAGE CONTENTS

1x Video Bar

1x DC 24V 5A Power Adapter

1x Remote Controller

1x Magnetic Lens Cap

1x Wall Mounting Kit

4x Expansion Screws

4x Mounting Screws

SPECIFICATIONS

AUDIO AND VIDEO	
Interface	1 x HDMI in, 1 x HDMI out, 1 x USB-C, 1 x USB-B, 1 x USB-A, 1 x Mic, 1 x GE, 1 x DC
Video Resolutions	4K@30Hz (Max)
Output Video Encoding	3840x2160 @ 30 Hz (max)

CAMERA AND SENSOR	
Lens	Fixed Focus
Sensor	CMOS, Effective Pixel: 8.0M
White Balance	Auto
Backlight Compensation	Auto
Digital Noise Reduction	2D, 3D Digital noise reduction supported
Viewing Angle	FOV: 120°
ePTZ	Supported 5 x Digital Zoom
HDR	Supported
Tracking Mode	Auto Framing / Speaker Tracking / Presenter Tracking

SPEAKERPHONE	
Microphone	4 x Linear microphone arrays with echo cancellation Pick-up Range: 5m-8m
Speaker	2 x 5 W

COMMUNICATION AND CONTROL	
HDMI	HDMI 2.0, HDCP 2.2
USB	USB-C: USB 3.0 host (60W max charging) USB-A: USB 3.0 device USB-B: USB 3.0 host
USB Protocol	UAC, UVC, USB HID
Ethernet	1 x RJ-45
WLAN	IEEE 802.11 a/b/g/n/ac
Control Methodw	Web UI, Bluetooth Remote Controller

GENERAL	
Operating Temperature	0°C ~ 45°C, 10% to 90%, non-condensing
Storage Temperature	-20°C ~ 60°C, 10% to 90%, non-condensing
MTBF	> 30000h
Power Supply	DC 24V 5A
Power Consumption	100W (Max)
Dimension (Width x Height x Depth)	700mm x 126.83 mm x 90mm (with Bracket)
Net Weight	2.42 kg (with Bracket)
Gross Weight	6.22 kg



PANEL DESCRIPTION

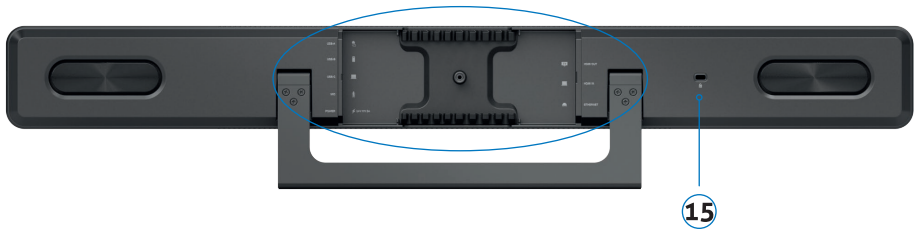
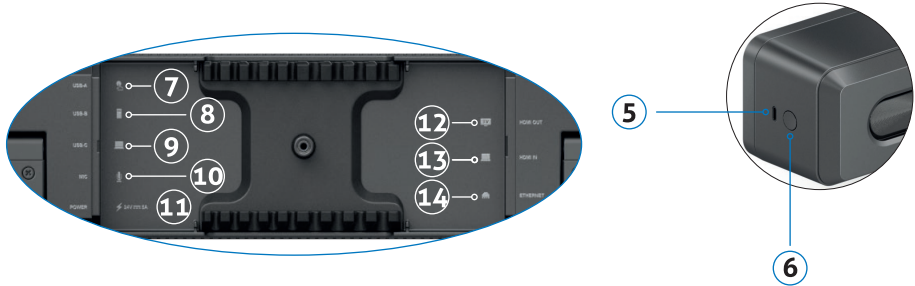
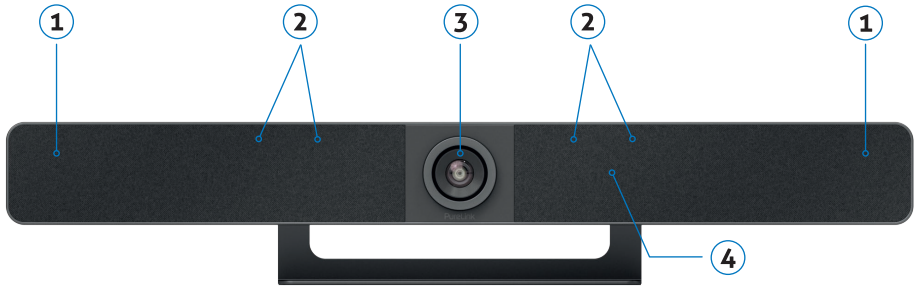

ID	NAME	DESCRIPTION
1	Speaker	2 x Speakers for audio signal output.
2	Microphone	4 x Linear microphone arrays for picking up sound.
3	Lens	Camera lens.
4	Status LED	<ul style="list-style-type: none"> • Blinking orange: The device is booting. • Constant white: The device is working properly. • Blinking white: The device is in standby state. • Blinking white very quickly: The device is being upgraded. • Blinking and white: The device is in sleep state. • Constant red: The device's microphone is muted. • Blinking blue: The device is in Bluetooth pairing state.
5	USB-C	Connect to the Dongle for pairing.
6	Pairing Button	Press and hold this button for more than 2 seconds to start pairing with the bluetooth remote controller.
7	USB-A	USB 3.0 Type-A port. Connect to a USB device such as touch screen.
8	USB-B	USB 3.0 Type-B port. Connect to the room PC for meetings.
9	USB-C	USB 3.0 Type-C port. USB PD: 60W max Connect to the laptop for meetings.
10	MIC	Connect to an external microphone.
11	Power	Connect to the power adapter provided for DC 24V 5A input.
12	HDMI Out	Connect to a HDMI display device or a capture card of the room PC.
13	HDMI In	Connect to a laptop.
14	Ethernet	Connect to a network device (e.g. network switch, wireless router, computer, etc.) for Airplay Mirroring signal input and LAN control (Web GUI & Telnet API).
15		Kensington security slot



INSTALLATION

Note: Before installation, ensure the device is disconnected from the power source.

To install the device on the wall:

1. Drill holes in the wall where appropriate, then insert the expansion screws provided into the wall. Secure the wall hanging bracket on the wall using the mounting screws provided.
2. Remove the stand from the device.
3. Screw the wall-mounted bracket to the device.
4. Attach the device's wall-mounted bracket to the wall hanging bracket on the wall.

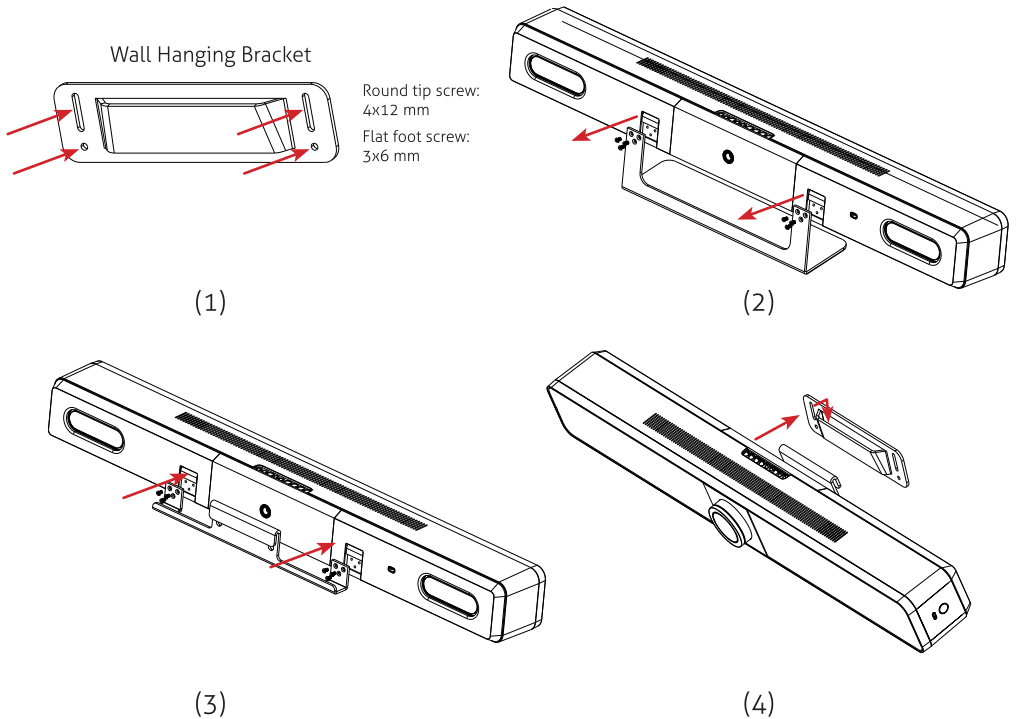

APPLICATION

1. BYOM

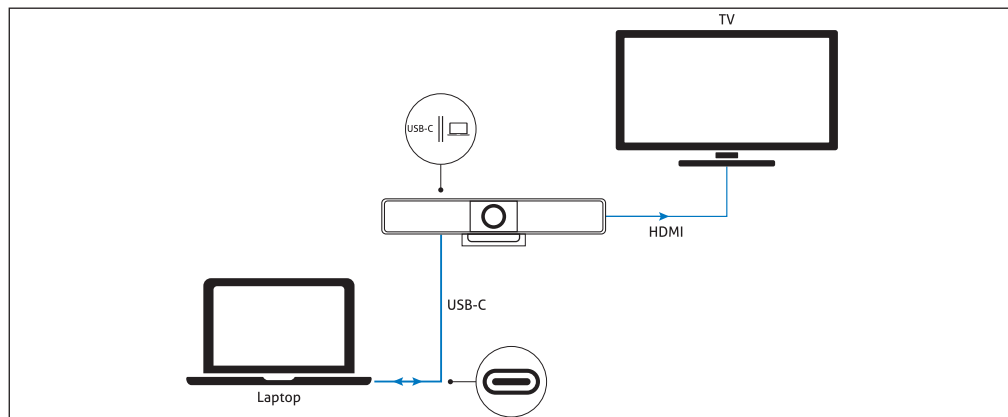

One Type-C AOC full function cable (optional) supports DP1.4, USB3.0, USB2.0 and PD (max 60W).

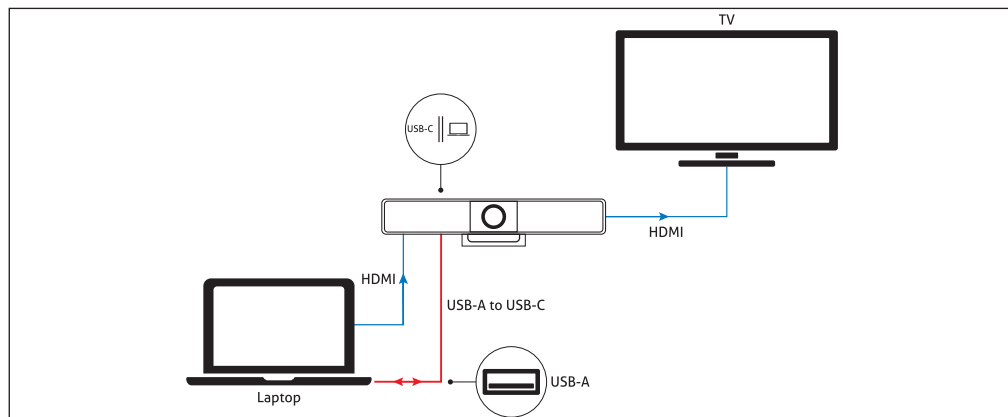

The second connection method is to use the standard HDMI and USB-A cables.



2.Zoom Room + BYOM

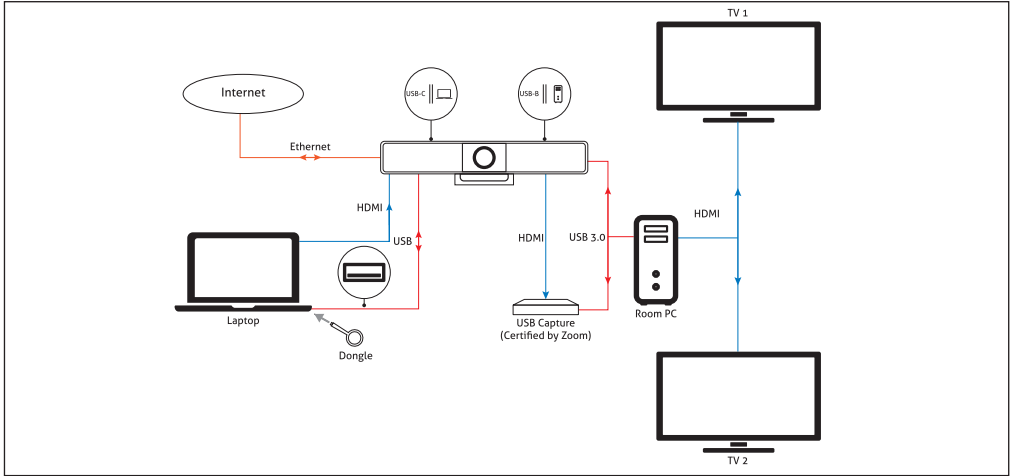

Dongle sold separately.

Note: After the device is connected to a computer, it can be detected by the system and specific applications with the following name:

- Model: VB300
- Camera/Speaker/Microphone: **VB300**

3. Microphone Cascading

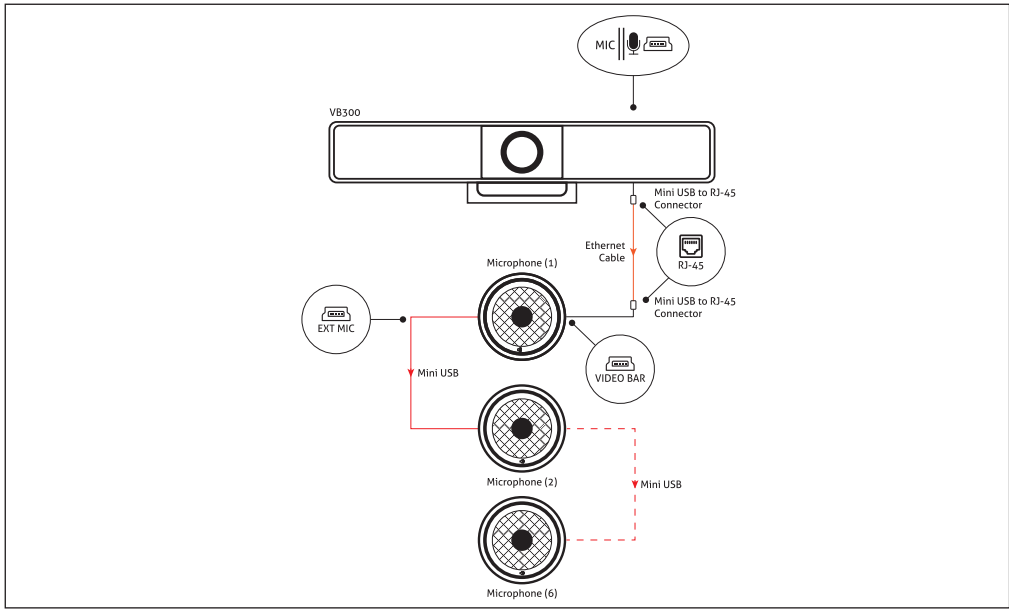
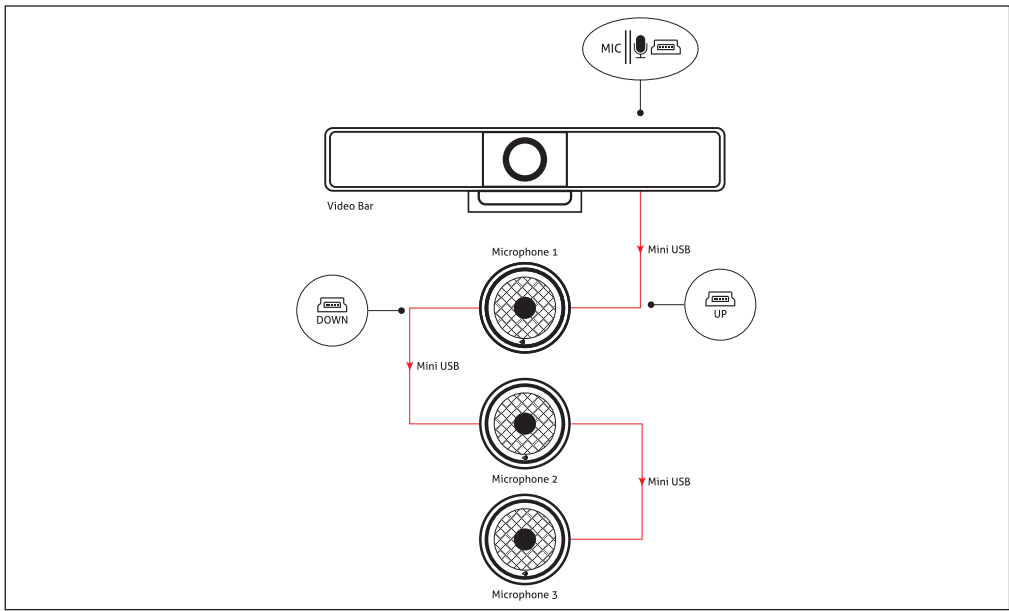



AUTOMATIC SIGNAL SWITCHING



Automatic signal switching function allows you to easily and quickly choose a source.

1. If screen display mode is set as Single Screen (default setting), signal switching follows Last-In-First-Out rule. In Single Screen mode, if a new video source inputs, the device will output it to the display screen.
2. If two video sources are being played in dual view (Split Screen), connect a new video source input to the device: when there's one hardware video source (HDMI/USB-C) at most among three sources, the latest input source will replace the source that has been displayed the longest on the screen; or the latest input source will replace the previous hardware video source.
3. If all video sources are removed, the device will output the Home Screen connection guide.

PAIRING WITH BLUETOOTH REMOTE CONTROLLER

The device can be controlled by the Bluetooth remote controller provided, after they have been successfully paired with each other.

To pair with the Bluetooth remote controller:



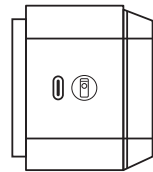





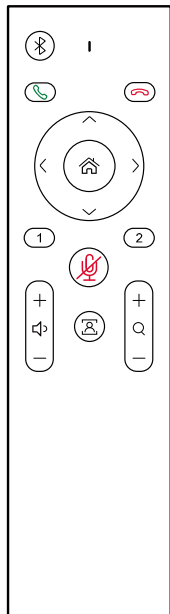

1. Press and hold the pairing button  on the enclosure's left side, the status LED will  blink blue, which indicates that the device enters Bluetooth pairing mode.



2. Press any button on remote controller, "**Remote Control Connected**" will appear on the display screen, indicating that Bluetooth pairing between the remote controller and the device is successful. Now you can use the remote controller to control the device with ease.

The following briefly introduces the functions of the remote controller buttons.

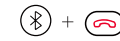

BUTTONS	DESCRIPTION
 Bluetooth	Press and hold the button for 2s to make the device to start pairing with other third-party Bluetooth device. (This function will be available in further versions)
 Answer	Press to answer the phone (available only when connect to a cellphone via Bluetooth).
 Hang up	Press to hang up the phone (available only when connect to a cellphone via Bluetooth).
 Home	<ul style="list-style-type: none"> Press to back to the default camera view (available only when Tracking mode is off). Press and hold the button for 2s to show OSD that includes IP address, model name, etc.
 Navigation	Press to perform ePTZ (only available when Trackingmode is off).
 Presets	<ul style="list-style-type: none"> Press and hold 3s to save current camera view to preset 1 or 2. Press to switch the camera view to preset 1 or 2. (Available only when Tracking mode is off)
 Mute/ Unmute	Press to toggle between mute and unmute.
 Volume	Press to adjust the volume. Press and hold to adjust the volume continuously.
 Tracking mode	Press to toggle among Auto Framing, Speaker Tracking and Off.
 Zoom	Press to adjust the zoom. Press and hold to adjust the zoom continuously.
	Press and hold the combination buttons for 3s, the remote controller will enter pairing mode.



SCREEN MIRRORING

With screen mirroring support, the device allows users to share multimedia content wirelessly from their mobile devices on any HDMI displays over Windows, Airplay Mirroring and Miracast.

USING APPLE DEVICES

Step 1: Connect your iPhone/iPad/Mac to the network on which the device runs.

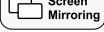
Step 2: Open Control Center on your Apple device, tap  to select appropriate mirroring device from the pop-up menu.

Note: For Apple device screen casting, please use the remote control to control the volume of VB300.

USING ANDROID PHONES

Take Samsung Galaxy series for example:

Step 1: Enable the Wi-Fi or WLAN feature of your mobile device.

Step 2: On your mobile device, swipe down from the top and tap



SmartView



Wireless
Projection

or to select appropriate mirroring device from the pop-up CONNECT menu.

USING THE DONGLE

Pre-Step: Plug the Dongle in to type-C port on the side of VB300 for pairing.

Step 1: Plug the Dongle in to your PC or Laptop.

Step 2: Press the button to start casting once the LED stops flashing.

USING WINDOWS PCS

Step 1: Enable the Wi-Fi or WLAN feature of your PC.

Step 2: On your PC, press the combination keys “ + K” to select appropriate mirroring device from the pop-up menu.

WEB UI

The Web UI designed for this device allows for basic settings. It can be accessed through a modern browser, e.g. Chrome, Safari, Firefox, etc.

To access the Web UI page:

1. Connect the Ethernet port of the device to a local area network. (Ensure there's a DHCP server in the network so that the switcher can obtain a valid IP address.)
2. Connect a PC to the same network as the device.
3. Input the device's IP address in the browser and press Enter, the following window will pop up.
Note: Default IP mode for this device is DHCP.

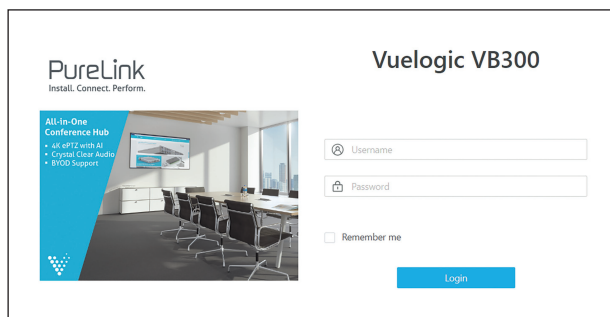

4. Input the user name and password (default user name & password: **admin**) and click **Login** to enter the main page.



The main page includes Overview, Camera, Settings and Support tabs.

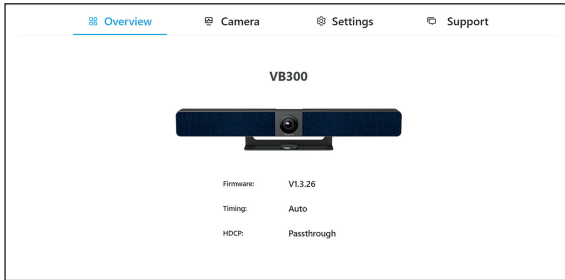

- Overview – offers basic information of the device.
- Camera – offers settings of camera parameters.
- Settings – offers basic settings of Video, Wi-Fi, BYOD, etc.
- Support – offers firmware update function and device information.

OVERVIEW

This page offers firmware version and status of output timing and HDCP settings for the device.

CAMERA

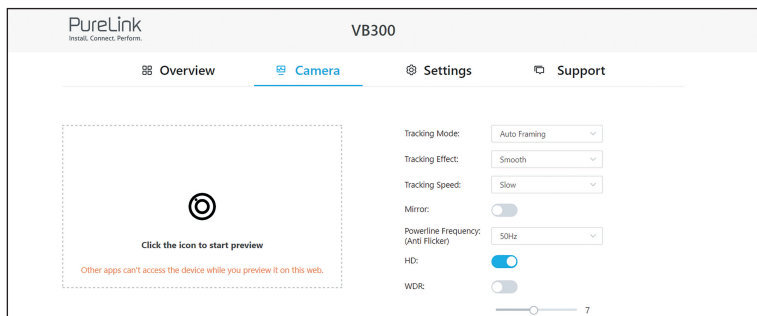

UI ELEMENTS	DESCRIPTION/OPTIONS
Tracking Mode	<ul style="list-style-type: none"> • Auto Framing is an AI feature to zoom, pan, and tilt intelligently so that everyone in the room is perfectly located in the picture. • Speaker tracking is an AI feature to intelligently focus on the person who is talking. When more than one person is speaking, it will automatically switch between speakers. • Presenter tracking is an AI feature to intelligently track the presenter, so that the presenter can always be in the best position on the screen even when constantly moving. • Off
Tracking Effect	<p>Tracking effect is available when Auto Framing is enabled.</p> <ul style="list-style-type: none"> • Smooth (default): The tracking image moves smoothly in the frame. • Immediate: The tracking image switches from one to another immediately in the frame.
Tracking Speed	<p>Tracking speed is available when Auto Framing is enabled.</p> <ul style="list-style-type: none"> • Slow (default) /Normal/Fast
Mirror	<ul style="list-style-type: none"> • Mirror image function • On: Image flipped horizontally. • Off (default setting): Image not flipped horizontally.
Powerline Frequency (Anti Flicker)	<p>Change the frequency to prevent flicker in the video.</p> <ul style="list-style-type: none"> • 50Hz (default) /60Hz



UI ELEMENTS	DESCRIPTION/OPTIONS
HD	<ul style="list-style-type: none">• On (default): Turn on for better image quality.• Off: Turn off for better compatibility.
	Click this icon to enable camera preview. Note: Other Apps cannot use the camera until camera preview is disabled.
WDR	When WDR is enabled, you can manually adjust the Backlight compensation value.

SETTINGS

GENERAL SETTINGS

PureLink
Install. Connect. Perform.

VB300

Overview Camera **Settings** Support

General Settings

Device Name

Device Name: VB300

The device name must be 1 to 20 characters long (letters, numbers, "_" or "-" only)
Note: Changing the device name will modify the SSID at the same time, and the Type-C Dongle needs to re-pairing.

Apply

IP Settings

IP Method: Static DHCP

IP Address: 169.254.1.100

Subnet: 255.255.0.0

Gateway: 192.168.100.11

Note: LAN Module will automatically reboot after changing network setting.

Apply

IP Conflict Detection

IP Conflict Detection:

UI ELEMENTS	DESCRIPTION/OPTIONS
Device Name	<p>Redefine the device name to an easy to remember one.</p> <p>Note: The name must be 1~20 characters in length, including letters, numbers, "_" or "-".</p> <p>By default, it's set as VB300.</p> <ul style="list-style-type: none"> Apply: Click to save and perform above settings. <p>Note: The device name is as same as the soft AP SSID. If you change to a new device name, you need to re-pair Dongle with this device as well.</p>
IP Method	Static / DHCP (default)
IP Address	Set IP address manually when Static mode is selected.
Subnet	Set subnet mask manually when Static mode is selected.
Gateway	Set gateway address manually for the device to communicate with another network that uses different communication protocols when Static mode is selected.
Apply	Click to save and perform above IP settings. (LAN module will reboot automatically once IP settings are changed.)
IP Conflict Detection	When IP Conflict Detection is enabled, an OSD prompt is displayed when an IP address conflict is detected



VIDEO SETTINGS

PureLink
Install. Connect. Perform.

VB300

Overview
Camera
Settings
Support

> General Settings

▼ Video Settings

Output

Timing:

HDCP:

Screen:

CEC

CEC:

One Touch Play:

Standby:

CEC command just supports Hex format with a maximum of 15 byte (example: 40 04).

CEC Test

UI ELEMENTS	DESCRIPTION/OPTIONS
Timing	Set output resolution for the device. Two options are offered: <ul style="list-style-type: none"> • Auto (default): Select to output the maximum resolution supported by the display based on the display's EDID. • Resolution range list: Select a desired output resolution from the dropdown menu to output this fixed resolution
HDCP	Set HDCP capability for the device's output. Four options are offered: <ul style="list-style-type: none"> • Pass-through (default)/HDCP 2.2/HDCP 1.4/Off
Screen	<ul style="list-style-type: none"> • Single Screen (default) • Split Screen: Dual view on one screen.
CEC	On (default)/Off: Select to enable/disable CEC control.
One Touch play	Enter the CEC one touch play command in hex of the controlled display device. For more information about the command, see the user guide of your display device. By default, it's set as "80 04".
Standby	Enter the CEC standby command in hex of the controlled display device. For more information about the command, see the user guide of your display device. By default, it's set as "80 36".
Apply	Click to save and perform above settings.
Load Default	Click to load default settings.
CEC Test	One Touch Play/Standby: Click to test if command setting takes effect.

WI-FI SETTINGS

PureLink
Install. Connect. Perform.

VB300

Overview Camera **Settings** Support

> General Settings
> Video Settings
▼ Wi-Fi Settings

Built-in WiFi

Band: 5G

Channel: Auto Manual

45

Apply

Soft AP

Soft AP:

Soft AP Router:

Password:

The password must be 8 to 20 characters long (letters, numbers, "." or "-" only)

Apply

UI ELEMENTS	DESCRIPTION/OPTIONS
Band	5G
Channel	<ul style="list-style-type: none"> Auto (default): The device selects a wireless channel for itself automatically. Manual: Assign a wireless channel for the device manually.
Soft AP	On (default)/Off
Soft AP Router	On (default)/Off
Password	Configure the soft AP password. By default, it is set as 12345678.
Apply	Click to save and perform above settings.
Operation Frequency	<ul style="list-style-type: none"> 2412MHz~2462MHz for WIFI 2.4G 5180MHz~5240MHz for WIFI 5G 2402~2480MHz for BT-EDR 2402~2480MHz for BT-BLE
Maximum Power	<ul style="list-style-type: none"> WIFI 2.4G 16.30dbm (E.I.R.P) WIFI 5G 14.81dbm (E.I.R.P)



BYOD SETTINGS

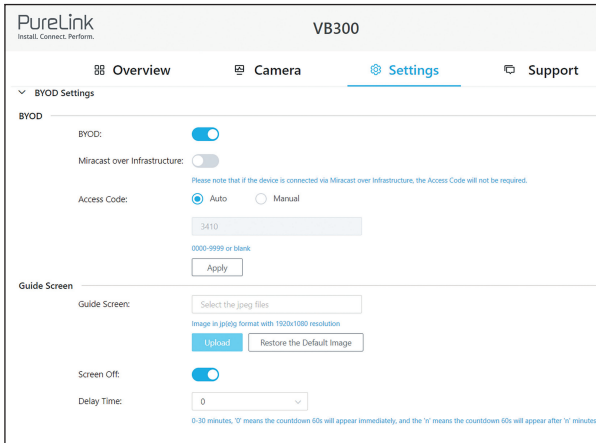

UI ELEMENTS	DESCRIPTION/OPTIONS
BYOD	On (default)/Off
Access Code	<p>The access code is used to help prevent users from accidentally connecting to an unintended device and protect from an unauthorized access.</p> <ul style="list-style-type: none"> • Auto: The device will randomly generate a four-digit access code in the following cases: <ul style="list-style-type: none"> ✓ The device switches to Guide Screen for output. ✓ The device reboots. • Manual: Select to input a four-digit code. <p>Access Code ON by default.</p>
Apply	Click to save and perform above settings.
Guide Screen	Click to select a Guide Screen image in .jpg format of 1920x1080 and upload to the device.
Screen off	Enable means that the screen will enter the countdown after the set time and then turn off. Disable means that the screen will never turn off.
Delay time	,0' means the countdown 60s will appear immediately, and the ,n' means the countdown 60s will appear after ,n' minutes.

SYSTEM SETTINGS

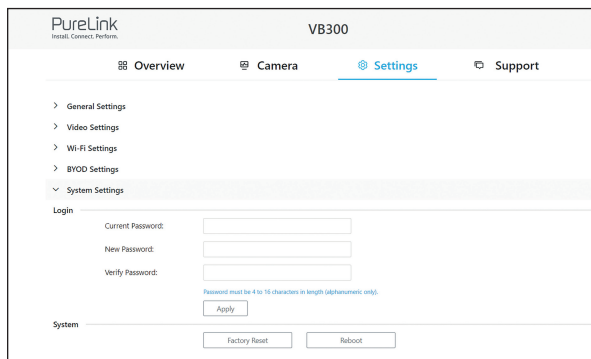

PureLink
Install. Connect. Perform.

VB300

Overview Camera Settings Support

> General Settings
> Video Settings
> Wi-Fi Settings
> BYOD Settings
▼ System Settings

Login

Current Password:

New Password:

Verify Password:

Password must be 4 to 16 characters in length (alphanumeric only).

Apply

System

Factory Reset Reboot

UI ELEMENTS	DESCRIPTION/OPTIONS
Login	Set a new password to login Web UI.
Apply	Click to save and perform above settings.
System	<ul style="list-style-type: none"> Factory Reset Reboot



SUPPORT

PureLink
Install. Connect. Perform.

VB300

Overview Camera Settings **Support**

Device Information

Device Model: VB300

Current Version: V1.3.26 ⓘ

Build Time: 2023.05.09 12:05:40

Firmware Update

Select the firmware files

[Upgrade & Reboot](#)

Note: Do not unplug the device while upgrading.

Support

[Click for support](#)

UI ELEMENTS	DESCRIPTION/OPTIONS
Device Information	Displays device model and firmware information.
Firmware Update	Select the firmware file and upload it for upgrade.
Support	https://www.purelink.de/de/anfrage-formular-purelink.de

TROUBLE SHOOTING

TROUBLE	TROUBLE SHOOTING
The key on remote has no reaction how to resolve?	Try to replace the battery in remote.
Press the Home button on remote, the picture of Camera can't return to panorama, how to resolve?	Please make sure the AI mode is off, this function is only effective in manual mode.
The HDMI OUT of VB300 no video output, how to check?	To check if the cables (HDMI IN / HDMI OUT / Type-C) have been plugged properly, re-plug the cables. To check if the display device has selected the correct input.
Why can VB300 only output at 720p when using third-party video conferencing apps like Zoom, Microsoft Teams, etc.	This is due to the limitations of third-party software, like Zoom and Microsoft Teams only support 720p now.
The Camera/Speaker/Mic of VB300 can't be recognized or the picture from Camera is abnormal, how to resolve?	Try using a different USB port on your computer. Try using a different USB cable.
The audio from Win10/11 system PC is stereo but the Left and Right speaker of VB300 is mono, how to resolve?	Click Win 10/11 system PC's start button, settings button, select Easy to use, select Audio, set mono audio OFF.
After connecting a new device to PC, PC's audio doesn't output from VB300, how to resolve?	Open the settings page of PC, in selecting output device select VB300.
win+k doesn't work on Windows PC	Please try to reboot the Windows PC.

For further support or questions please contact us under <https://www.purelink.de/en/anfrage-formular-purelink.de> or scan the QR- code below





CE CONFORMITY



PureLink GmbH hereby declares that this product is in compliance with the essential requirements and other relevant provisions of the **RED Directive 2014/53/EU** and the **RoHS Directive 2011/65/EU amended by 2015/863/EU**.



PureLink GmbH hereby declares that this product is in compliance with the essential requirements of the **Electromagnetic Compatibility Regulations 2016** and all other applicable UK regulations. The EU Declaration of Conformity is available here:

www.purelink.de

DISPOSAL OF DEVICE



WEEE-Reg.-Nr. DE 93847290

According to the European WEEE Directive, electrical and electronic equipment may not be disposed of with household waste. As a consumer, you are obliged to return electrical and electronic equipment free of charge at the end of its service life to the public collection points set up for this purpose or to the point of sale. Details on this are regulated by the respective national law.

The symbol on the product, the instructions for use or the packaging refers to these regulations. Recycling old appliances in this way is an important contribution to the protection of our environment.

BATTERY RECYCLING INFORMATION

Batteries and accumulators must not be disposed of in household waste. Please dispose of used batteries and accumulators properly, following local regulations. Consumers in Germany are required by law to take all batteries and accumulators to a collection point in their community/borough or to retailers to have them disposed of in an environmentally friendly way. Otherwise they pose a potential risk to the environment and to human health.

DISCLAIMER OF LIABILITY

PureLink GmbH will not be held liable, nor provide any warranty for damage resulting from improper installation, assembly and use of the product, or failure to observe the operating instructions and/or safety instructions.

TRADEMARK

Product model and logo are trademarks. All other trademarks mentioned in this manual are acknowledged as the property of the trademark owners. No part of this publication may be copied or reproduced without prior written permission of their respective owners.



PureLink GmbH

Von-Liebig-Str. 10
D - 48432 Rheine
Germany
www.purelink.de

WEEE-Reg.-No. DE 93 847 290

PureLink UK LTD.

Carpenter Court, 1 Maple Road
Bramhall, Stockport
Cheshire SK7 2DH
United Kingdom

V1 | 2023-07